

Avalanche Victim Resuscitation Checklist



Teaching presentation – v2015E - generic

ICAR MEDCOM: Kottmann A, Blancher M, Pasquier M, Spichiger T, Brugger H



Contents

1. Introduction
2. Concept
3. Definitions
4. BLS Provider Phase
5. ALS Provider Phase
6. Example
7. Conclusions

1. Introduction

- Some specific informations that are decisive for medical decisions can be obtained **only** during the extrication and first assessment of an avalanche victim.
- It is common that these informations are collected by not professionally-trained rescue members, without a medical or paramedical education level.
- These informations have direct consequences for both the pre-hospital and in-hospital treatment of patients. It is of utmost importance to collect these parameters in a common, standardized way and to communicate them throughout the whole rescue operation.

1. Introduction

- A retrospective analysis of the management of buried avalanche victims showed that the triage and treatment algorithm is not always followed. A considerable number of patients in cardiac arrest without obvious fatal trauma and with prolonged duration of burial (respectively hypothermia) and patent or unknown airway were not resuscitated (CPR) or were declared dead though survival chances and prognosis in these potentially hypothermic patients may have been favourable.
- On the other hand, patients with prolonged burial and an obstructed airway were sent to ECC (extracorporeal circulation), though in this case patients are already dead and resuscitation is not required.

Contents

1. Introduction
2. Concept
3. Definitions
4. BLS Provider Phase
5. ALS Provider Phase
6. Example
7. Conclusions

2. Concept

- There are many factors that make avalanche accidents particularly challenging for rescuers, e.g. adverse environmental conditions, the time factor, and pressure in making medical decisions and accepting their consequences. It is well known that decisiveness and judgement may be limited in such circumstances.
- In aviation it is common for pilots to manage critical situations by following emergency procedures in the form of a checklist. Each point in the checklist is read aloud, executed and confirmed before moving to the next point.
- We adapted the avalanche victim management algorithm published in 2015 by the ERC (European Resuscitation Council) to create a checklist. We consulted existing recommendations¹ for development of medical checklists.

¹Development of medical checklists for improved quality of patient care. HALES et al, Int J for Quality in Health Care 2008;20(1):22–30.

2. Concept

- The first version of the Avalanche Victim Resuscitation Checklist was validated on 18.10.2013 by the ICAR MEDCOM and published in *Resuscitation* in 2015.¹ This first version has been updated on 16.10.2015 to follow the new ERC (European Resuscitation Council) recommendations.²
- The aim of this project is to increase resuscitation of patients with a real chance of survival, i.e. hypothermic patients with patent or unknown airway.
- Likewise, to optimize use of resources and to avoid resuscitation of patients with no chance of survival.

1. The Avalanche Victim Resuscitation Checklist, a new concept for the management of avalanche victims, Kottmann A et al. *Resuscitation*. 2015 Jun;91:e7-8. doi: 10.1016/j.resuscitation.2015.03.009.

2. Truhlar A, et al. European Resuscitation Council Guidelines for Resuscitation 2015 Section 4. *Resuscitation* 2015.

2. Concept

AVALANCHE VICTIM RESUSCITATION CHECKLIST

© ICAR MEDCOM, 16.10.2015, Kottmann A, Blancher M, Pasquier M, Brugger H

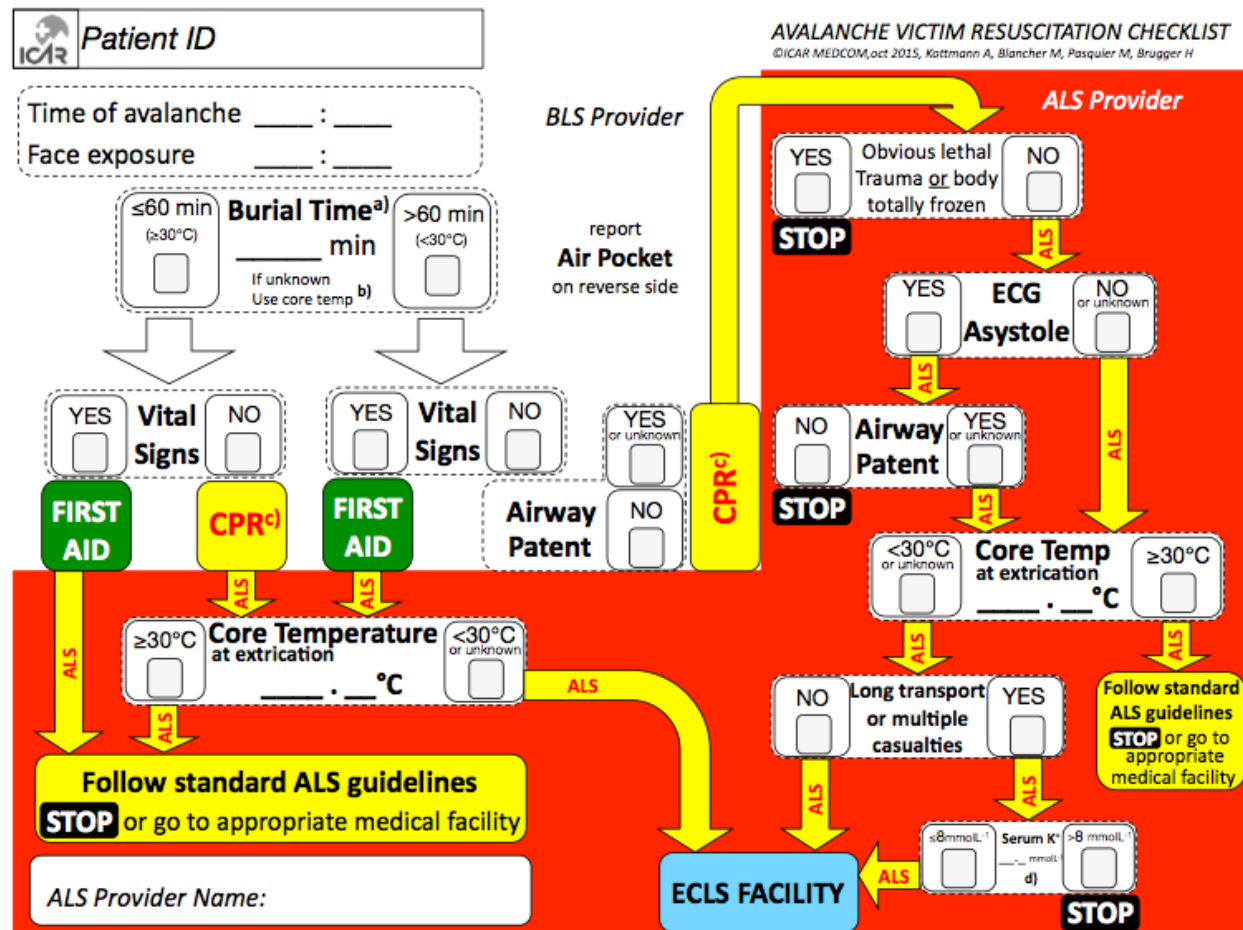

2. Concept

A checklist is assigned to every avalanche victim as soon as their head and upper body are extricated. The checklist should be completed by the rescuers step-by-step throughout the rescue operation.

The white section can be completed by rescuers with BLS (Basic Life Support) training, i.e. emergency care providers, laypersons, avalanche dog handlers, ski patrollers, mountain guides, etc.

The red section can be completed by rescuers with ALS (Advanced Life Support) training, i.e. physicians, emergency medical technicians and paramedics (in accordance with national regulations).

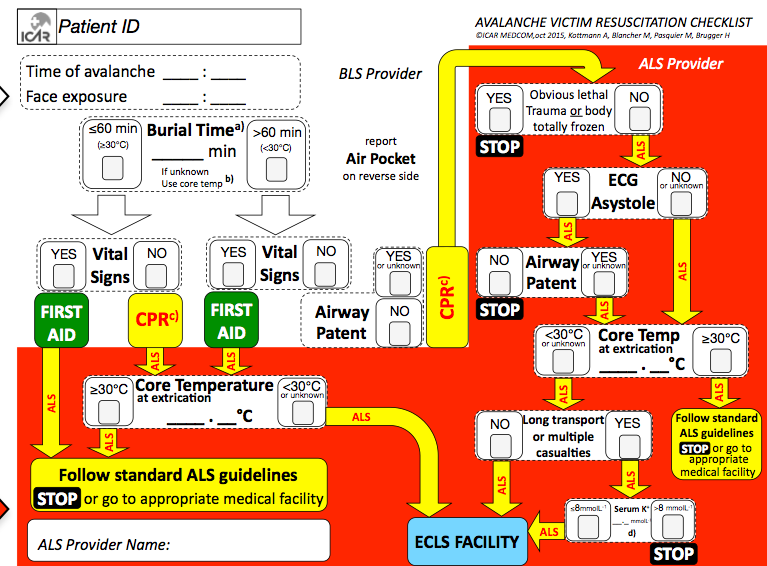

2. Concept

The checklist can be marked with pencil, ball-point pen or waterproof permanent pen.

Careful!

Pencil is the best option in low ambient temperatures and moist conditions.

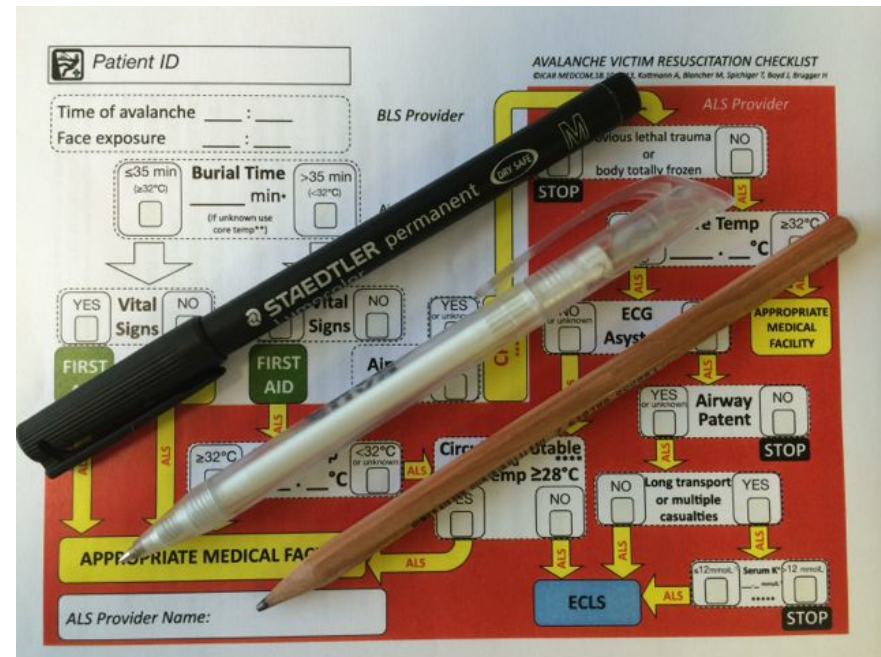

2. Concept

The checklist should remain on the patient until hospital admission to guarantee transfer of information.

ECLS: YES or NO?

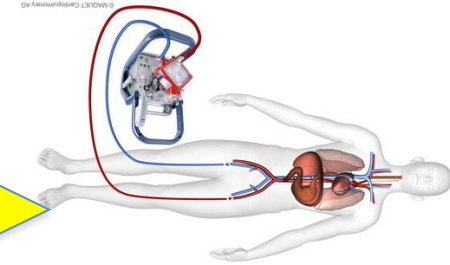

2. Concept: Country/service specific slide

Discuss how to collect the copies of the checklist in your country/
region.
For example...

Contents

1. Introduction
2. Concept
3. Definitions
4. BLS Provider Phase
5. ALS Provider Phase
6. Example
7. Conclusions

3. Definitions

- **BLS (Basic Life Support):** basic life-saving measures that can be performed by laypersons with BLS training and by professional rescuers. BLS includes CPR (cardiopulmonary resuscitation), clearing of the airway and ventilation. A BLS provider with additional training can also use a semi-automated defibrillator (AED)
- **BLS Provider:** person with BLS training
- **ALS (Advanced Life Support):** measures in addition to BLS that include advanced airway management (e.g. intubation) and administration of drugs. ALS is performed by health care professionals with ALS training (physicians, paramedics or other personnel in accordance with national regulations)
- **ALS Provider:** person with ALS training

3. Definitions

- **Patient ID:** identity of the patient
- **Burial Time:** defined as the time between avalanche release (burial) and uncovering the face
- **Core Temperature:** oesophageal temperature if the patient is in cardiac arrest or intubated, measured with a device adapted to low temperatures. In non-intubated patients with vital signs, tympanic measurement can be used, if the device has (i) a thermistor probe (not infrared) and insulation of the ear from cold environmental air (for example with a headset) and (ii) that the external ear canal is not obstructed.



3. Definitions

- **Vital Signs:** normal respiration, coughing or movements (large or small) by the patient; pulse (for ALS providers only)
- **First Aid:** basic treatment measures, e.g. stabilization of the head-neck-spine, recovery position, minimizing bleeding, immobilization of a fracture, management of a wound with bandages, protection against cold

3. Definitions

- **Airway Patent:** any airway that is not completely obstructed by compacted snow or debris
- **Air Pocket:** an air space of any size around the victim's mouth or nose that may have allowed a victim to breath while buried
- **CPR:** cardiopulmonary resuscitation includes chest compressions and ventilation
- **Obvious lethal trauma:** the only trauma that should be defined as lethal or not compatible with life are:
 1. decapitation
 2. truncal transection*

Multiple fractures and/or injury to the face and skull are not considered not compatible with life.

* Complete transection of the body including inner organs and major blood vessels anywhere between the shoulders and hips.

3. Definitions

- **Body totally frozen:** whole body is frozen solid or the thorax is incompressible. Note: some degree of stiffness, especially of the extremities, can be a clinical sign of hypothermia stage IV
- **Circulation stable:** circulatory instability is defined as ventricular arrhythmias or systolic blood pressure <90mmHg
- **Appropriate medical facility:** a facility appropriate to treat the patient's most severe injury
- **ECLS or Extracorporeal Life Support:** a general term referring to various techniques for extracorporeal circulation, e.g. CPB (cardiopulmonary bypass) or ECMO (extracorporeal membrane oxygenation)

On the following slides the symbol



refers to a note or treatment method relevant to ALS providers.

Please take a checklist to follow the next slides of the presentation

Complete the checklist with a pencil for the given examples

Contents

1. Introduction
2. Concept
3. Definitions
- 4. BLS Provider Phase**
5. ALS Provider Phase
6. Example
7. Conclusions

3. BLS Provider Phase

The checklist is completed step-by-step and parallel to the patient management and rescue operation. Start in the upper left corner and insert numbers or crosses as appropriate.

There is an arrow after each box directing you to the next question or to the indicated treatment.

In the example shown here (right) the rescuer should start CPR.

ICAR Patient ID *M Dupond*

Time of avalanche II : 22
 Face exposure II : 48

Burial Time^{a)} 26 min
≤60 min (≥30°C) >60 min (<30°C)
If unknown Use core temp^{b)}

report **Air Pocket** on reverse side

Vital Signs YES NO

Vital Signs YES NO

Airway Patent YES or unknown NO

Treatment: FIRST AID (green), **CPR^{c)}** (yellow)

3. BLS Provider Phase

Patient ID: use either an ascending number (1,2,3, etc.) or the number on the mass casualty event triage card.

Burial Time:
 If the time of the avalanche release is not clear but the burial time is close to 60 min, a burial time of >60 min should be assumed.

If the time of the avalanche release is not known, core temperature is necessary to detect hypothermia.

In the example shown here (right) the rescuer should start CPR.

ICAR Patient ID *M. Dupond*

Time of avalanche 11 : 22
 Face exposure 12 : 28

Burial Time^{a)} 66 min

≤60 min (≥30°C) >60 min (<30°C)

If unknown Use core temp^{b)}

Vital Signs: YES NO YES NO YES or unknown

FIRST AID CPR^{c)} FIRST AID Airway Patent NO CPR^{c)}

BLS Provider report Air Pocket on reverse side

3. BLS Provider Phase

When possible estimate the size of the air pocket and record it on the back of the card.

Air Pocket

Yes, ___ x ___ x ___ (cm)

No

Unknown

ICAR Patient ID *M. Dupond*

Time of avalanche 11 : 22
 Face exposure 12 : 28

≤60 min (≥30°C) **Burial Time^{a)}** 66 min >60 min (<30°C)
 If unknown Use core temp^{b)}

BLS Provider

report **Air Pocket** on reverse side

Vital Signs: normal respiration, coughing or movements (pulse for ALS providers)

First Aid: management using the ABCDE principle

YES Vital Signs NO

FIRST AID **CPR^{c)}**

YES Vital Signs NO

FIRST AID **Airway Patent**

YES or unknown NO

CPR^{c)}

CPR: in case of hypoxic cardiac arrest (which is the primary cause of death in buried avalanche victims) resuscitation guidelines suggest standard CPR. Combined CPR with chest compressions and ventilation should be used.

3. BLS Provider Phase

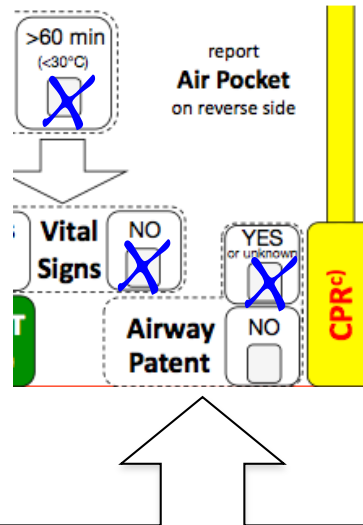

Airway Patent: the airway is defined as not patent only when it is completely obstructed with compacted snow.

Though the airway status is a decisive factor later in the algorithm, it is important to evaluate immediately since it is one of the first elements that can be observed after the patient's face is uncovered

This does not change normal procedures as the rescuer should always check and manage the airways as necessary at this stage.

Treatment steps at this stage of management are not dependent on whether the airway is patent or not; in both cases **the rescuer should start CPR** (after opening the airway).

3. Transition: BLS provider to ALS provider

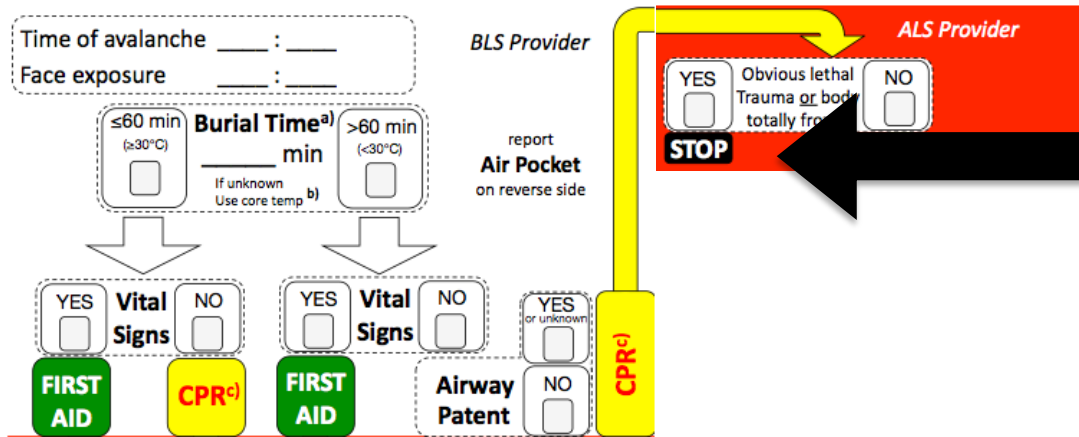

The decision to terminate CPR can be made only by a physician or a person authorized by national regulations to do so.

The BLS provider is responsible for the management of the patient until an ALS provider takes over.

The red section shows the decisions and treatment steps for ALS providers.

If there is no ALS provider present, the BLS provider should continue with BLS and first aid measures until an ALS provider can take over.

In a critical situation (terrestrial rescue, loss of daylight, poor weather conditions, etc.) and if no ALS provider is present, the ALS provider should be contacted (funk, telephone) to discuss further treatment and decisions.

CPR can be interrupted if the risk for the rescuer is unacceptably high.

Contents

1. Introduction
2. Concept
3. Definitions
4. BLS Provider Phase
5. ALS Provider Phase
6. Example
7. Conclusions

5. ALS Provider Phase

- Treatment in this phase should conform to international Advanced Life Support standards such as ACLS, ATLS, PHTLS
- Correct treatment of an avalanche victim requires familiarity with the following publications:
 - *Accidental hypothermia*
Brown et al, New Engl J Med 2012;367(20):1930–38
 - *European Resuscitation Council Guidelines for Resuscitation 2015 Section 4.*
Truhlar A, et al. Resuscitation 2015

5. ALS Provider Phase

- There are various reasons why an ALS provider might not have sufficient information to make a particular decision (e.g. exposed terrain, lack of materials). If information is missing, the checklist follows the most favourable route for the patient.
- Example:
 - If core temperature is unknown, the patient is considered hypothermic
 - If there is no ECG available, it is assumed that the patient is not in asystole
- Treatment measures such as a resuscitation attempt should be performed continuously whenever possible while subsequent steps of the checklist are being evaluated.

5. ALS Provider Phase

Obvious lethal trauma¹: decapitation or truncal transection (see definitions)

A buried avalanche victim in cardiac arrest with signs of injury (polytrauma or multiple fractures) must be resuscitated and reversible causes of the arrest should be excluded (e.g. tension pneumothorax).

Body totally frozen¹: if the thorax is incompressible resuscitation is not possible and the ALS provider can withhold resuscitation.

Some degree of stiffness can be a clinical sign of hypothermia stage IV. These patients must be resuscitated.

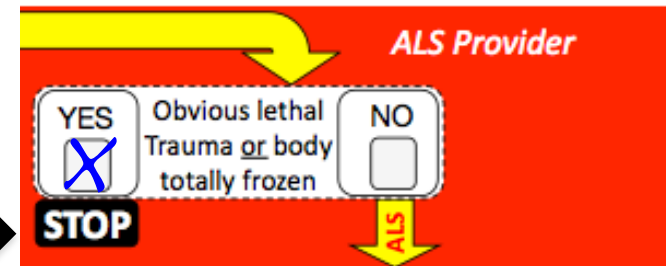

¹ Termination of Cardiopulmonary Resuscitation in Mountain Rescue
Paal et al, High Altitude Medicine & Biology 2012;13(3):200-8.

5. ALS Provider Phase

Asystole is confirmed with standard procedures (increase the amplitude and switch to another lead).
If there is no ECG available, assume that the patient is not in asystole.

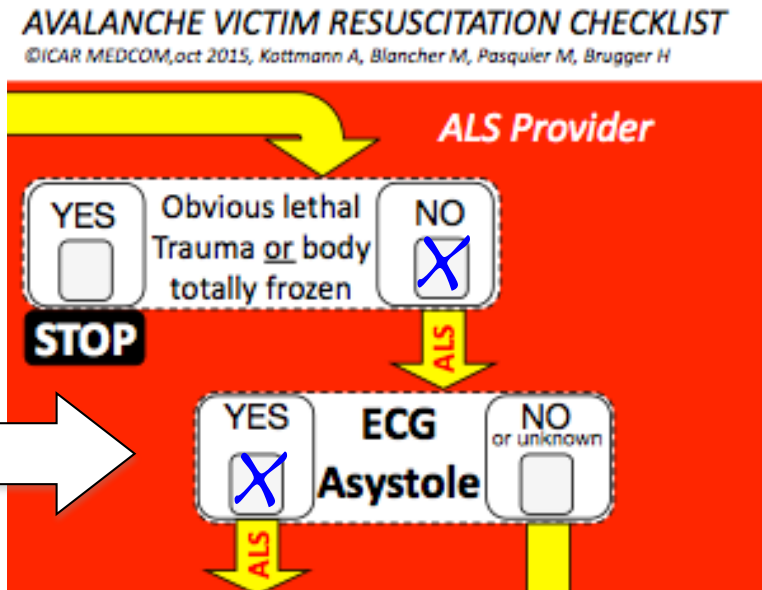

Cardiac rhythm should be assessed as soon as possible. Ideally before any disturbance (and particularly torso extrication) of unresponsive patients in order to detect a “rescue collapse”. This is defined as a Cardiac Arrest occurring when a patient with deep hypothermia is being rescued; it has a good outcome if treated actively.

1. Pasquier M, et al. Does rescue collapse mandate a paradigm shift in the field management of avalanche victims? High Alt Med Biol. 2015.
2. Boué Y, et al. Survival after avalanche-induced cardiac arrest. Resuscitation. 2014.

5. ALS Provider Phase

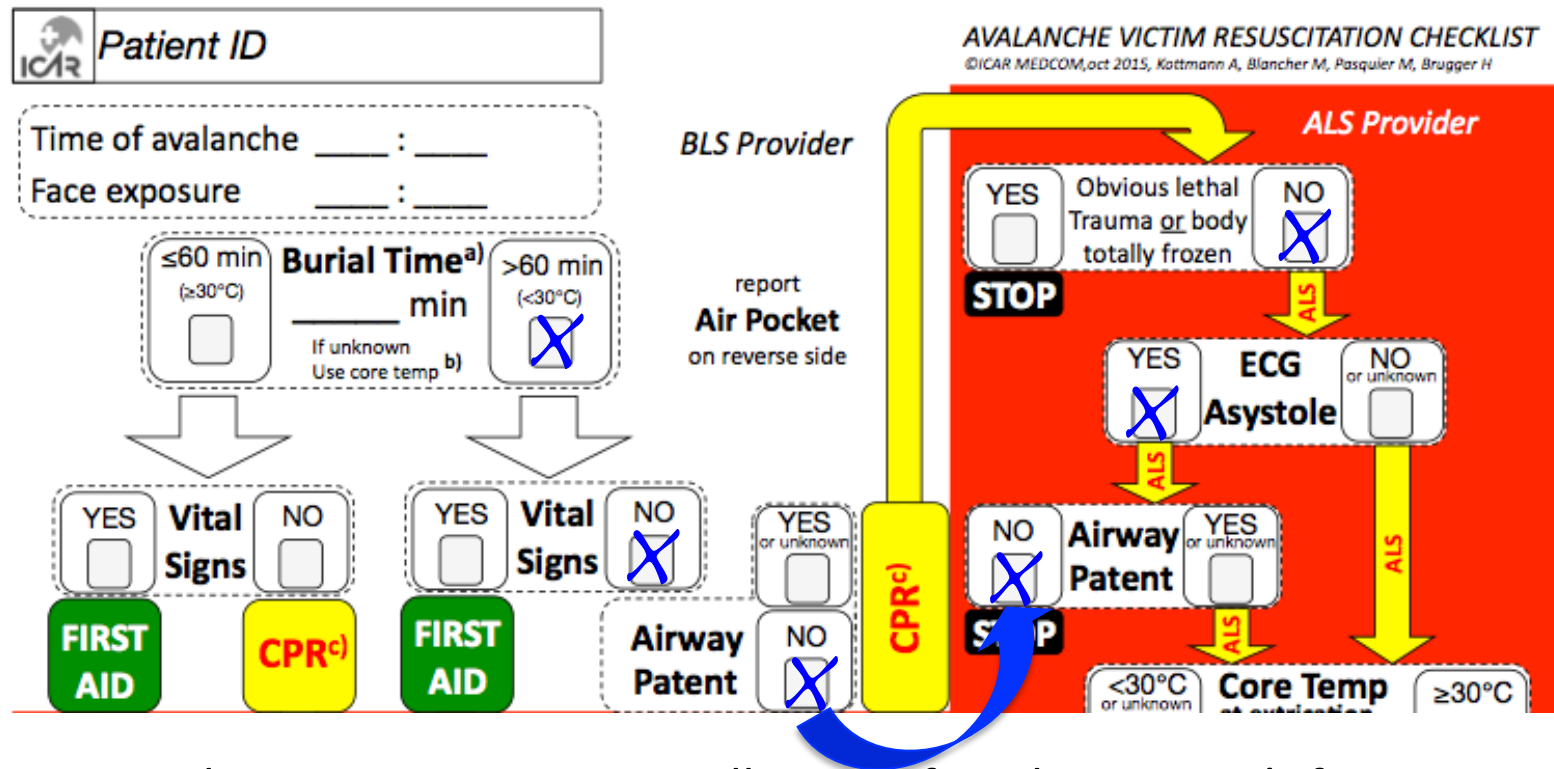

Information on the airway status was collected after the patient's face was uncovered and reported in the white section. The ALS provider should copy the information from the white section to this box in the red section.

At this point the airway status information is fundamental for further treatment and may result in termination of CPR!

5. ALS Provider Phase

Core Temperature (see definition) should be measured immediately when the patient is extricated. When it is measured lately, it should not be used as a triage criteria. The cooling rate in outside environment could be higher than in the snow.

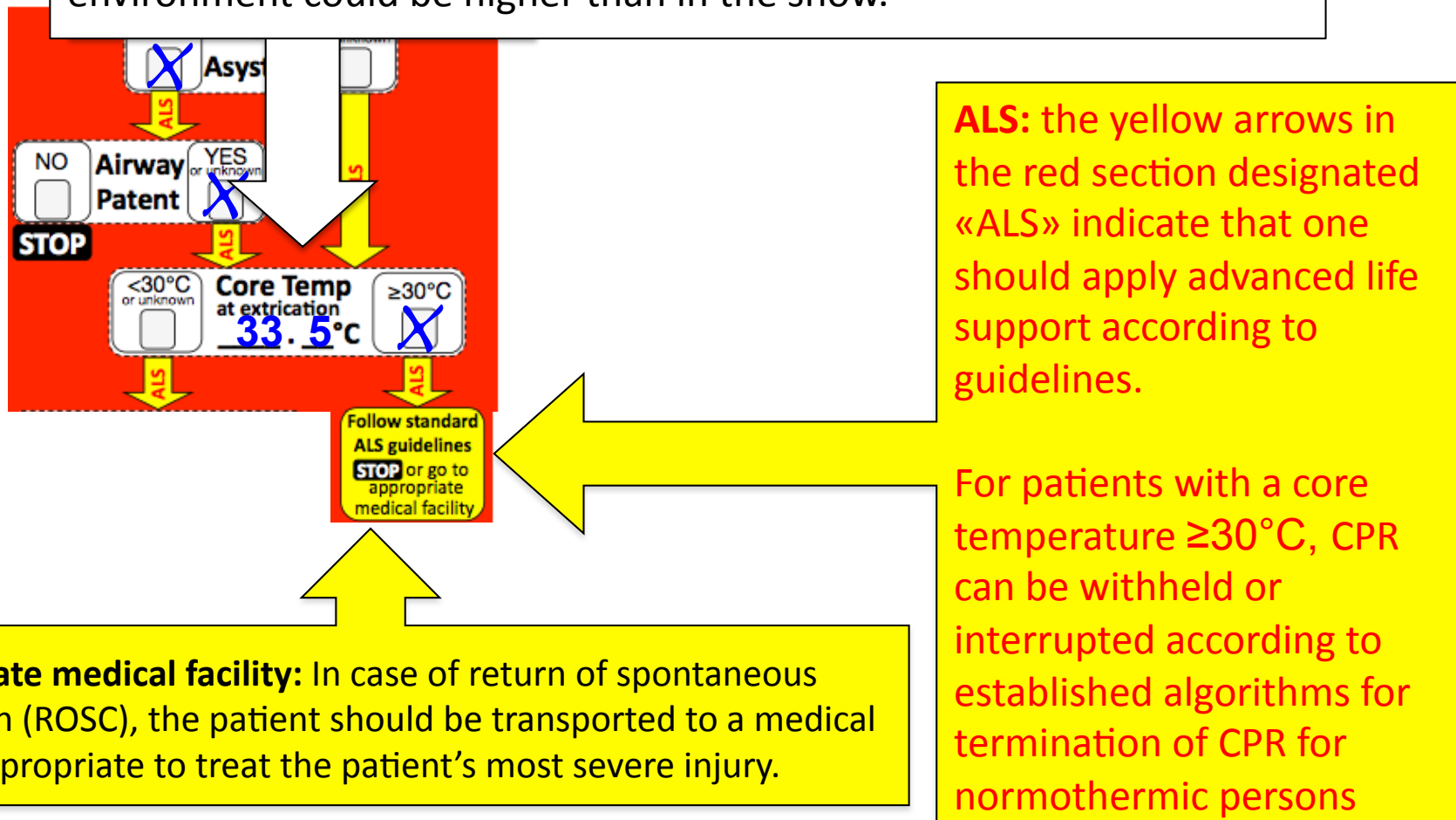

ALS: the yellow arrows in the red section designated «ALS» indicate that one should apply advanced life support according to guidelines.

For patients with a core temperature $\geq 30^{\circ}\text{C}$, CPR can be withheld or interrupted according to established algorithms for termination of CPR for normothermic persons

Appropriate medical facility: In case of return of spontaneous circulation (ROSC), the patient should be transported to a medical facility appropriate to treat the patient's most severe injury.

5. ALS Provider Phase

Patients with Core T° $\geq 30^{\circ}\text{C}$ with vital signs or return of spontaneous circulation (ROSC) should be transported to appropriate medical facility.
In case of cardiac arrest without ROSC, resuscitation can be stopped after a minimum of 20 min according to ALS standards.

Follow standard ALS guidelines
STOP or go to appropriate medical facility

All other cases (including patients with unknown core temperature and/or hemodynamic status) should be transported to a hospital with ECLS facilities.

ECLS FACILITY

5. ALS Provider Phase

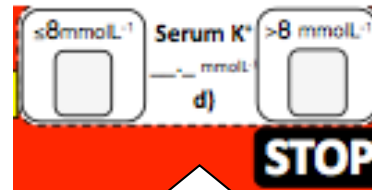

Serum potassium (K^+) is a predictive survival factor in hypothermic cardiac arrest victims (Serum potassium should be measured in an arterial sample only). In a systematic review of prognostic factors in avalanche resuscitation, the highest admission K^+ in a patient with ROSC was 8 mmol/l, the highest K^+ with survival was 6.4 mmol/l.

ERC Recommendations 2015

At this point, K^+ can be used to assist the decision whether a hypothermic patient in cardiac arrest should continue to be resuscitated or transported to a center with ECLS:

- $K^+ \leq 8 \text{ mmol/L}$ indicates continued resuscitation and transported to a center with ECLS
- $K^+ > 8 \text{ mmol/L}$, consider termination of resuscitation.

5. ALS Provider Phase

Depending on geographic and meteorological conditions, but also in the case of multiple victim avalanches where the number of patients outweighs the transport resources (or the availability of ECLS facilities), an intermediate stop at a medical facility to measure potassium should be considered.

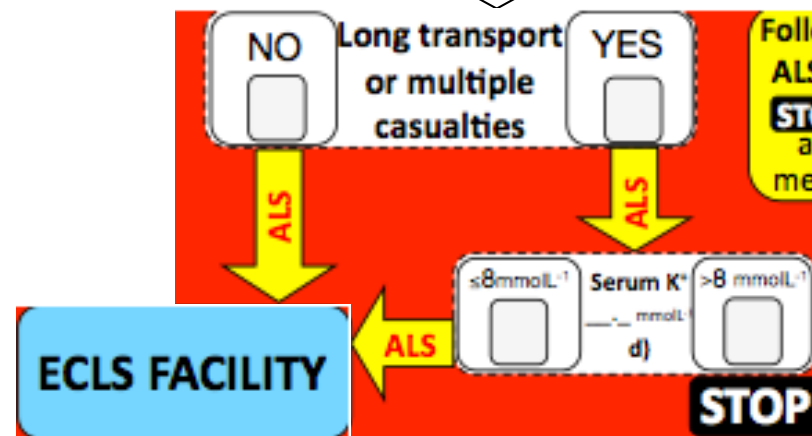

5. Phase ALS Provider

Even when burial time is less than ≤ 60 min, Core T° should be measured ¹ during extrication in order to exclude a cooling rate $\geq 9,4^\circ/h^2$.

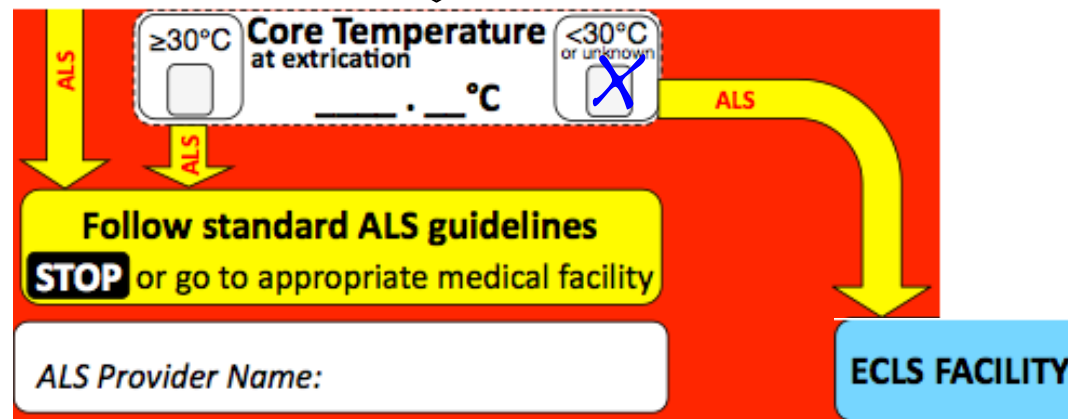

1. Truhlar A, et al. European Resuscitation Council Guidelines for Resuscitation 2015 Section 4. *Resuscitation* 2015.
2. Pasquier M, et al. Cooling rate of 9.4°C in an hour in an avalanche victim. *Resuscitation*. 2015.

5. Phase ALS Provider

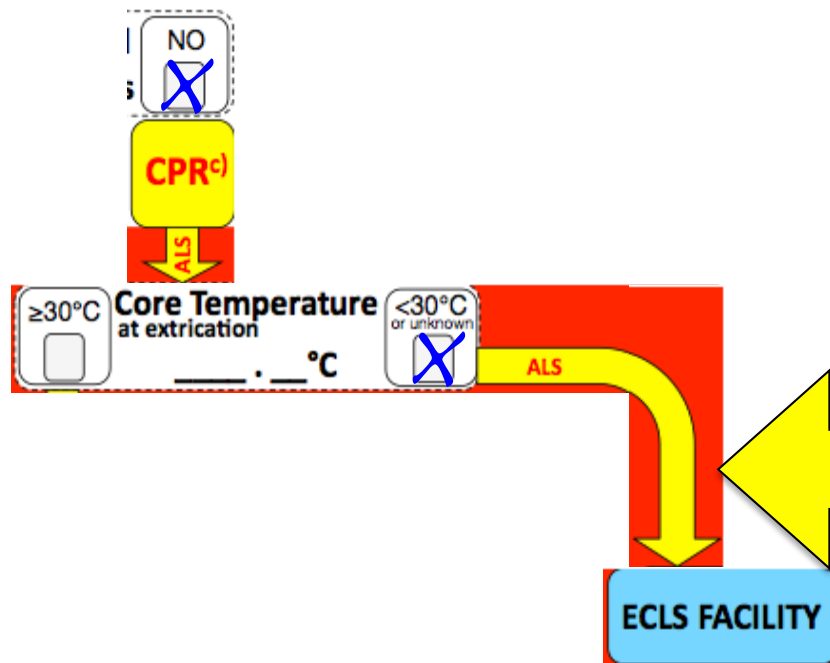

If core T° at extrication is $< 30^{\circ}\text{C}$ or unknown, patient should be transported to an ECLS centre, under CPR if needed. Ideally those patients should be assessed based on ECG (asystole: yes/no), airway patency (yes or no) as for patients with burial time of more than 60 min. However, probability to face this situation (burial time < 60 min and Core T° $< 30^{\circ}\text{C}$) is very low. For design reasons and in order to adapt the checklist to the 2015 ERC recommendations before winter time 2015, we consider acceptable to transport those “exceptional” patients to an ECLS centre for further triage.

If ALS provider faces an obvious lethal trauma or a patient with asystole and an obstructed airway, resuscitation can be stopped.

5. ALS Provider Phase

Country/service specific slide

- List of ECLS centers in the country/region
- Recommendations about local transport destination, strategies for measuring K+, etc.

5. ALS Provider Phase

A correctly completed checklist provides the necessary information to properly manage the patient. Thus the checklist must remain with the patient when admitted to the hospital staff.

ALS Provider Name:

The ALS provider inserts his/her name in capital letters at the bottom left, completes the fields on the back of the card, makes a copy of both sides and keeps it with a copy of the mission protocol.

**Rescue
Service**

At Medical Facility delivery, make a copy, a scan or a digital photograph of this checklist and keep it with the copy of your rescue mission protocol.

Contents

1. Introduction
2. Concept
3. Definitions
4. BLS Provider Phase
5. ALS Provider Phase
6. Example
7. Conclusions

6. Example

Refer to the following articles for further details on the management and treatment decisions shown in the next slides:

- Brown D et al. Accidental Hypothermia. *New Engl J Med* 2012;367:1931-8
- Truhlar A et al. ERC Resuscitation Guidelines 2015 Section 4 Special Circumstances. *Resuscitation* 2015;95:148-201

6. Example

Take a training checklist and insert the following information in pencil:

- January, elevation 2020m, danger level 3, slope 35-40°, exposition NW, clear weather
- a slab avalanche was triggered and a group of 5 skiers were caught (during ascent)
- size: max 1.5m (crown depth), 50m (width), 200m (length)
- release between **12:35 and 12:45** according to witnesses



6. Example: Patient Nr. 1

Access to face at 13:00

- ☞ no obvious traumatic injuries, greyish colour in face
- ☞ no air pocket
- ☞ does not react to stimulation (does not open eyes or make any sounds or movements)

A snow in mouth (not compacted)

B no movements of the thorax visible

C no palpable pulse (carotid or radial)



6. Example: Patient Nr. 1, BLS

1. CPR

CPR

External chest compressions and ventilations (incl. oxygen and defibrillation)

2. Minimize heat loss

Only if this does not interfere with the quality of CPR

3. Spine stabilization

All avalanche victims can have polytrauma

Hypothermia is not the cause of cardiac arrest in patient Nr. 1: he was buried for <60min, which is not long enough for core temperature to drop enough. The fastest estimated cooling rate in a completely buried avalanche victim is 9 to 9.4°C/h.^{1,2}

However, core T° should always be measured (oesophageal), because a faster cooling rate is possible in some circumstances.

¹ Oberhammer R, Beikircher W, Hörmann C, et al. Full recovery of an avalanche victim with profound hypothermia and prolonged cardiac arrest treated by extracorporeal re-warming. Resuscitation 2008;76:474-80.

² Pasquier M, et al. Cooling rate of 9.4°C in an hour in an avalanche victim. Resuscitation. 2015.



Patient ID

AVALANCHE VICTIM RESUSCITATION CHECKLIST

©ICAR MEDCOM, oct 2015, Kottmann A, Blancher M, Pasquier M, Brugger H

Time of avalanche 12 : 35

Face exposure 13 : 00

Burial Time^{a)}

≤60 min (≥30°C) **25** min >60 min (<30°C)

If unknown Use core temp^{b)}

BLS Provider

ALS Provider

report
Air Pocket
on reverse side

YES Obvious lethal Trauma or body totally frozen NO

STOP

YES **ECG Asystole** NO or unknown

Example for a temperature ≥30°C

YES **Vital Signs** NO

FIRST AID

CPR^{c)}

FIRST AID

Airway Patent NO

CPR^{c)}

Patent **STOP**

<30°C or unknown **Core Temp at extrication** 34 . 5 °C ≥30°C

≥30°C **Core Temperature at extrication** 34 . 5 °C <30°C or unknown

NO Long transport or multiple casualties YES

Follow standard ALS guidelines **STOP** or go to appropriate medical facility

Follow standard ALS guidelines
STOP or go to appropriate medical facility

<8 mmol·L⁻¹ **Serum K⁺** mmol·L⁻¹ >8 mmol·L⁻¹

ECLS FACILITY

STOP

ALS Provider Name:



Patient ID

AVALANCHE VICTIM RESUSCITATION CHECKLIST

©ICAR MEDCOM, oct 2015, Kottmann A, Blancher M, Pasquier M, Brugger H

Time of avalanche 12 : 35
Face exposure 13 : 00

Burial Time^{a)}
≤60 min (≥30°C)
25 min
>60 min (<30°C)
If unknown Use core temp^{b)}

BLS Provider

ALS Provider

report
Air Pocket
on reverse side

YES Obvious lethal Trauma or body totally frozen NO
STOP

YES **ECG Asystole** NO or unknown
ALS

Example for a temperature <30°C

YES **Vital Signs** NO
FIRST AID

CPR^{c)}
ALS

FIRST AID
ALS

Airway Patent NO
CPR^{c)}

Patent
STOP

<30°C or unknown **Core Temp at extrication** _____ °C ≥30°C
ALS

≥30°C **Core Temperature at extrication** 29.5 °C <30°C or unknown
ALS

Follow standard ALS guidelines
STOP or go to appropriate medical facility

NO **Long transport or multiple casualties** YES
ALS

Follow standard ALS guidelines
STOP or go to appropriate medical facility

<8 mmolL⁻¹ **Serum K⁺** _____ mmolL⁻¹ >8 mmolL⁻¹
STOP

ECLS FACILITY

ALS Provider Name:

6. Example: Patient Nr. 1, BLS



Reflections



The cause of the cardiocirculatory arrest could be asphyxia or non-visible traumatic injuries.

Standard BLS techniques should be used, though it is possible for an ALS provider to decide to terminate CPR if there is no return of spontaneous circulation on site, but this should be done in accordance to resuscitation algorithms for normothermic patients (not hypothermic).

6. Example: Patient Nr. 2

First assessment at 13:45

- ☞ no obvious traumatic injuries, pale face
- ☞ not able to determine presence of an air pocket during extrication
- ☞ does not react to stimulation (does not open eyes or make sounds)

A small amount of snow in mouth, nostrils filled with snow

B thorax expansion visible (ca. 4x/min)

C no palpable pulse (carotid or radial)

ALS
Provider



Patient ID

AVALANCHE VICTIM RESUSCITATION CHECKLIST

©ICAR MEDCOM, oct 2015, Kottmann A, Blancher M, Pasquier M, Brugger H

Time of avalanche 12 : 35

Face exposure 13 : 45

Burial Time^{a)}

≤60 min (≥30°C) _____ min >60 min (<30°C)

If unknown Use core temp^{b)}

BLS Provider

report
Air Pocket
on reverse side

ALS Provider

YES **Vital Signs** NO

FIRST AID

CPR^{c)}

YES **Vital Signs** NO

FIRST AID

YES or unknown **Airway Patent** NO

CPR^{c)}

YES Obvious lethal Trauma or body totally frozen NO

STOP

YES **ECG Asystole** NO or unknown

ALS

NO **Airway Patent** YES or unknown

STOP

<30°C or unknown **Core Temp at extrication** _____ °C ≥30°C

ALS

NO Long transport or multiple casualties YES

ALS

Follow standard ALS guidelines **STOP** or go to appropriate medical facility

≥30°C **Core Temperature at extrication** _____ °C <30°C or unknown

ALS

Follow standard ALS guidelines **STOP** or go to appropriate medical facility

ALS Provider Name:

ECLS FACILITY

<8 mmol·L⁻¹ **Serum K⁺** _____ mmol·L⁻¹ >8 mmol·L⁻¹

d)

STOP

6. Example: Patient Nr. 2, BLS

1. Minimize heat loss

Active external, minimally invasive rewarming techniques¹

2. Continued monitoring

The risk is high that his clinical status will worsen (cardiac arrest)

3. Spine immobilization

All avalanche victims can have polytrauma

4. Minimize movements

Avoid rescue collapse, i.e. induced cardiac arrest in a patient in deep hypothermia at extrication or during transport.

Patient Nr. 2 is potentially hypothermic: he was buried for >60min, but he may have had an air pocket and thus been able to breath (*Note: if this is not known, always treat favourably*) and his airways were at least partially patent. His respiratory rate at extrication was 4x/min.

1. Accidental hypothermia, Brown et al, New Eng J Med 2012;367(20):1931-38.

6. Example: Patient Nr. 2, BLS



Reflections



At this stage it is necessary to measure core temperature.

If core temperature is $\geq 30^{\circ}\text{C}$, he should be transported to a hospital with appropriate facilities to treat the most severe injury.

In all other cases (including the ones where temperature could not be measured), the patient should be transported to a hospital with ECLS facilities.



Patient ID

AVALANCHE VICTIM RESUSCITATION CHECKLIST

©ICAR MEDCOM, oct 2015, Kottmann A, Blancher M, Pasquier M, Brugger H

Time of avalanche 12 : 35

Face exposure 13 : 45

Burial Time^{a)}

≤60 min (≥30°C) _____ min >60 min (<30°C)

If unknown Use core temp^{b)}

BLS Provider

report
Air Pocket
on reverse side

ALS Provider

YES Obvious lethal Trauma or body totally frozen NO

STOP

YES **ECG Asystole** NO or unknown

YES or unknown

NO **Airway Patent** YES or unknown

YES **Vital Signs** NO

YES **Vital Signs** NO

FIRST AID

CPR^{c)}

FIRST AID

Example for a temperature <30°C

Core Temperature at extrication

≥30°C 29.5 °C <30°C or unknown

_____ °C

Follow standard ALS guidelines
STOP or go to appropriate medical facility

NO Long transport or multiple casualties YES

Follow standard ALS guidelines **STOP** or go to appropriate medical facility

ALS Provider Name:

ECLS FACILITY

<8 mmol⁻¹ Serum K⁺ >8 mmol⁻¹ _____ mmol⁻¹

d)

STOP



Patient ID

AVALANCHE VICTIM RESUSCITATION CHECKLIST

©ICAR MEDCOM, oct 2015, Kottmann A, Blancher M, Pasquier M, Brugger H

Time of avalanche 12 : 35

Face exposure 13 : 45

Burial Time^{a)}

≤ 60 min ($\geq 30^\circ\text{C}$)
 > 60 min ($< 30^\circ\text{C}$)

_____ min

If unknown Use core temp^{b)}

BLS Provider

ALS Provider

report
Air Pocket
on reverse side

YES Obvious lethal Trauma or body totally frozen
 NO

STOP

YES **ECG Asystole**
 NO or unknown

YES **Vital Signs**
 NO

YES **Vital Signs**
 NO

YES or unknown

NO **Airway Patent**
 YES or unknown

FIRST AID

CPR^{c)}

FIRST AID

Example for a temperature $\geq 30^\circ\text{C}$

Core Temperature at extrication

$\geq 30^\circ\text{C}$
 $< 30^\circ\text{C}$ or unknown

34 . 5 °C

_____ °C

Follow standard ALS guidelines

STOP or go to appropriate medical facility

NO Long transport or multiple casualties
 YES

Follow standard ALS guidelines **STOP** or go to appropriate medical facility

ECLS FACILITY

< 8 mmol⁻¹ Serum K⁺
 > 8 mmol⁻¹

_____ mmol⁻¹ d)

STOP

ALS Provider Name:

6. Example: Patient Nr. 3

First assessment at 13:40

Blood **i**n the snow around the patient's head

- ☞ 10cm wound on the head, greyish **skin** colour, blue lips
- ☞ not able to determine presence of an air pocket during extrication
- ☞ does not react to stimulation (does not open eyes or make any sounds or movements)

A small amounts of snow in mouth and nostrils

B no movements of the thorax visible

C no palpable pulse (carotid or radial)



An open femur fracture was found upon extrication.



Patient ID

AVALANCHE VICTIM RESUSCITATION CHECKLIST

©ICAR MEDCOM, oct 2015, Kottmann A, Blancher M, Pasquier M, Brugger H

Time of avalanche 12 : 35

Face exposure 13 : 40

Burial Time^{a)}

≤60 min (≥30°C) _____ min >60 min (<30°C)

If unknown Use core temp^{b)}

BLS Provider

report
Air Pocket
on reverse side

ALS Provider

YES **Vital Signs** NO

FIRST AID

CPR^{c)}

YES **Vital Signs** NO

FIRST AID

YES or unknown **Airway Patent** NO

CPR^{c)}

YES **Obvious lethal Trauma or body totally frozen** NO

STOP

YES **ECG Asystole** NO or unknown

ALS

NO **Airway Patent** YES or unknown

STOP

<30°C or unknown **Core Temp at extrication** _____ °C ≥30°C

ALS

≥30°C **Core Temperature at extrication** _____ °C <30°C or unknown

ALS

NO **Long transport or multiple casualties** YES

ALS

Follow standard ALS guidelines **STOP** or go to appropriate medical facility

Follow standard ALS guidelines
STOP or go to appropriate medical facility

<8 mmol⁻¹ **Serum K⁺** _____ mmol⁻¹ >8 mmol⁻¹

d)

STOP

ECLS FACILITY

ALS Provider Name:

6. Example: Patient Nr. 3, BLS

1. CPR **CPR**

2. Stop bleeding

3. Minimize heat loss

4. Spine stabilization

5. Minimize movements

Patient Nr. 3 is potentially hypothermic: he was buried between 55 and 65 min (*Note: because this spans the 60min threshold, duration of burial should be recorded as >60min*). He may have had an air pocket and thus been able to breath and his airways were patent.

Note: a face wound and an open femur fracture are NOT lethal injuries.

6. Example: Patient Nr. 3, ALS



5. Evaluate cardiac rythm

Asystolic yes or no

6. Advanced airway management: report information

In case of Asystole, report the information about the patentness of the airway which is documented in the BLS part. At this stage, the information about the initial patentness of the airway becomes fundamental.

In case of an asystolie and an obstructed airway, resuscitation can be stopped.

In case of an asystolie and a patent airway, core temperature measurement is the next step.



Patient ID

AVALANCHE VICTIM RESUSCITATION CHECKLIST

©ICAR MEDCOM, oct 2015, Kottmann A, Blancher M, Pasquier M, Brugger H

Time of avalanche 12 : 35

Face exposure 13 : 40

Burial Time^{a)}

≤60 min (≥30°C) _____ min >60 min (<30°C)

If unknown Use core temp^{b)}

BLS Provider

report
Air Pocket
on reverse side

ALS Provider

YES **Vital Signs** NO

FIRST AID

CPR^{c)}

YES **Vital Signs** NO

FIRST AID

YES or unknown **Airway Patent** NO

CPR^{c)}

YES Obvious lethal Trauma or body totally frozen NO

STOP

YES **ECG Asystole** NO or unknown

NO **Airway Patent** YES or unknown

STOP

<30°C or unknown **Core Temp at extrication** _____ °C ≥30°C

NO Long transport or multiple casualties YES

Follow standard ALS guidelines **STOP** or go to appropriate medical facility

≥30°C **Core Temperature at extrication** _____ °C <30°C or unknown

Follow standard ALS guidelines **STOP** or go to appropriate medical facility

ALS Provider Name:

ECLS FACILITY

<8 mmol⁻¹ **Serum K⁺** _____ mmol⁻¹ >8 mmol⁻¹

d)

STOP

6. Example: Patient Nr. 3, ALS



7. Evaluate the core temperature

If the patient is in cardiac arrest, assess the oesophageal temperature.

If temperature at extrication is $\geq 30^{\circ}\text{C}$, standard ALS (for normothermic patient) should be performed.

In case of a cardiac arrest without ROSC (return of spontaneous circulation), the resuscitation can be stopped after the recommended treatment times if there has been no ROSC.



Patient ID

AVALANCHE VICTIM RESUSCITATION CHECKLIST

©ICAR MEDCOM, oct 2015, Kottmann A, Blancher M, Pasquier M, Brugger H

Time of avalanche 12 : 35

Face exposure 13 : 40

Burial Time^{a)}

≤60 min (≥30°C)
 _____ min
 >60 min (<30°C)

If unknown Use core temp^{b)}

BLS Provider

report
Air Pocket
on reverse side

ALS Provider

YES **Vital Signs** NO

FIRST AID

CPR^{c)}

YES **Vital Signs** NO

FIRST AID

YES or unknown
 NO

Airway Patent

CPR^{c)}

YES Obvious lethal Trauma or body totally frozen NO

STOP

YES **ECG Asystole** NO or unknown

NO **Airway Patent** YES or unknown

STOP

<30°C or unknown **Core Temp at extrication** _____ °C ≥30°C

Follow standard ALS guidelines **STOP** or go to appropriate medical facility

≥30°C **Core Temperature at extrication** _____ °C <30°C or unknown

NO **Long transport or multiple casualties** YES

<8 mmol⁻¹ **Serum K⁺** _____ mmol⁻¹ >8 mmol⁻¹

d)

Follow standard ALS guidelines **STOP** or go to appropriate medical facility

ALS Provider Name:

ECLS FACILITY

STOP

6. Example: Patient Nr. 3, ALS



7. Evaluate the core temperature

If $T^{\circ} < 30^{\circ}\text{C}$ or unknown, hypothermia can be the cause of cardiac arrest and the following steps of the checklist must be followed.

If resources are limited and transport time to a center with ECLS facilities is long, an intermediate stop should be considered to measure K^{+} ; this can be used as a criteria to decide if resuscitation should be continued and transport to ECLS is appropriate.

The serum potassium should be measured from an arterial blood sample.



Patient ID

AVALANCHE VICTIM RESUSCITATION CHECKLIST

©ICAR MEDCOM, oct 2015, Kottmann A, Blancher M, Pasquier M, Brugger H

Time of avalanche 12:35

Face exposure 13:40

Burial Time^{a)}

≤60 min (≥30°C)
 _____ min
 >60 min (<30°C)

If unknown Use core temp^{b)}

BLS Provider

report
Air Pocket
on reverse side

ALS Provider

YES Obvious lethal Trauma or body totally frozen
 NO

STOP

YES **ECG Asystole**
 NO or unknown

NO **Airway Patent**
 YES or unknown

STOP

<30°C or unknown
 ≥30°C

Core Temp at extrication
24.5 °C

NO Long transport or multiple casualties
 YES

Follow standard ALS guidelines **STOP** or go to appropriate medical facility

<8 mmol·l⁻¹
 Serum K⁺
 >8 mmol·l⁻¹

STOP

YES **Vital Signs**
 NO

FIRST AID

CPR^{c)}

YES **Vital Signs**
 NO

FIRST AID

Airway Patent

YES or unknown
 NO

CPR^{c)}

≥30°C
 <30°C or unknown

Core Temperature at extrication
_____ °C

Follow standard ALS guidelines **STOP** or go to appropriate medical facility

ECLS FACILITY

ALS Provider Name:

6. Example: Patient Nr. 4

Access to face at 14:00

- ☞ no obvious traumatic injuries, greyish colour to skin
- ☞ no obvious air pocket seen at extrication
- ☞ does not react to stimulation
- ☞ arms are stiff, crossed position

A compact snow in mouth and throat

B no movements of the thorax visible

C no palpable pulse (carotid or radial)





Patient ID

AVALANCHE VICTIM RESUSCITATION CHECKLIST

©ICAR MEDCOM, oct 2015, Kottmann A, Blancher M, Pasquier M, Brugger H

Time of avalanche 12 : 35
Face exposure 14 : 00

Burial Time^{a)}

≤60 min (≥30°C) min >60 min (<30°C)
If unknown Use core temp^{b)}

BLS Provider

report
Air Pocket
on reverse side

ALS Provider

YES **Vital Signs** NO
FIRST AID

CPR^{c)}

YES **Vital Signs** NO
FIRST AID

YES or unknown
 NO
Airway Patent

CPR^{c)}

YES **Obvious lethal Trauma or body totally frozen** NO
STOP

YES **ECG Asystole** NO or unknown
ALS

NO **Airway Patent** YES or unknown
STOP

<30°C or unknown **Core Temp at extrication** °C ≥30°C
ALS

≥30°C **Core Temperature at extrication** °C <30°C or unknown
ALS

NO **Long transport or multiple casualties** YES
ALS

Follow standard ALS guidelines **STOP** or go to appropriate medical facility

Follow standard ALS guidelines
STOP or go to appropriate medical facility

<8 mmol·L⁻¹ **Serum K⁺** mmol·L⁻¹ >8 mmol·L⁻¹
d)

ECLS FACILITY

STOP

ALS Provider Name:

6. Example: Patient Nr. 4, BLS

1. CPR **CPR**

2. Minimize heat loss

3. Spine stabilization

4. Minimize movements

Patient Nr. 4 is potentially hypothermic: he was buried >60min. It is likely that he could not breath due to obstruction of the airways with compacted snow.

Compliance with BLS procedures is still valid; **the status of the airways does not change the course of action at this stage of the rescue/checklist!** Every avalanche victim should be resuscitated except if he/she has lethal trauma (see definitions).

Note: Stiffness of the extremities alone is not sufficient to declare death.

6. Example: Patient Nr. 4, ALS



5. Evaluate cardiac rhythm

Asystole, confirmed with maximum amplitude and two leads.

6. Are the airways patent?

The patient's airways were partially freed by the first responders but they were not able to ventilate. The airway was obviously blocked by compacted snow in the throat. At this stage the ALS provider can consider terminating CPR. The information about the patentness of the airway had been noted at the beginning. This is now available for the ALS Provider to assimilate its importance.



Patient ID

AVALANCHE VICTIM RESUSCITATION CHECKLIST

©ICAR MEDCOM, oct 2015, Kottmann A, Blancher M, Pasquier M, Brugger H

Time of avalanche 12 : 35

Face exposure 14 : 00

Burial Time^{a)}

≤60 min (≥30°C)
 _____ min
 >60 min (<30°C)

If unknown Use core temp^{b)}

BLS Provider

report
Air Pocket
on reverse side

ALS Provider

YES **Vital Signs** NO

FIRST AID

YES **Vital Signs** NO

FIRST AID

YES or unknown
 NO

Airway Patent

CPR^{c)}

YES Obvious lethal Trauma or body totally frozen
 NO

STOP

YES **ECG Asystole**
 NO or unknown

NO **Airway Patent**
 YES or unknown

STOP

<30°C or unknown
 _____ °C
 ≥30°C

Core Temp at extrication

≥30°C
 _____ °C
 <30°C or unknown

Core Temperature at extrication

NO Long transport or multiple casualties
 YES

Follow standard ALS guidelines **STOP** or go to appropriate medical facility

Follow standard ALS guidelines **STOP** or go to appropriate medical facility

<8 mmol·L⁻¹ Serum K⁺
 _____ mmol·L⁻¹
 >8 mmol·L⁻¹

STOP

ECLS FACILITY

ALS Provider Name:

6. Example: Patient Nr. 5

He was caught in the avalanche and was buried for some time while still in movement, but was able to free himself after the avalanche stopped. He made the alarm call.

- ☞ no symptoms
- ☞ oriented and calm
- ☞ shivering

6. Example: Patient Nr. 5, BLS

1. Minimize heat loss

Active external, minimally invasive rewarming techniques + sweet and warm drinks (only if he can swallow normally and will not be operated in the next 2 hours)

2. Spine stabilization

All avalanche victims can have polytrauma

Patient Nr. 5 must be sent to hospital to exclude non-visible injuries.

It is also possible that he could develop a secondary lung edema up to hours later since he was buried (even if burial time was very short).



Patient ID

AVALANCHE VICTIM RESUSCITATION CHECKLIST

©ICAR MEDCOM, oct 2015, Kottmann A, Blancher M, Pasquier M, Brugger H

Time of avalanche 12 : 35

Face exposure 12 : 36

Burial Time^{a)}

≤60 min (≥30°C) min >60 min (<30°C)

If unknown Use core temp^{b)}

BLS Provider

report
Air Pocket
on reverse side

ALS Provider

YES Obvious lethal Trauma or body totally frozen NO

STOP

YES **ECG Asystole** NO or unknown

NO **Airway Patent** YES or unknown

STOP

<30°C or unknown **Core Temp at extrication** ≥30°C

____ . ____ °C

NO **Long transport or multiple casualties** YES

Follow standard ALS guidelines **STOP** or go to appropriate medical facility

<8 mmol.L⁻¹ **Serum K⁺** >8 mmol.L⁻¹

____ mmol.L⁻¹ d)

STOP

ECLS FACILITY

YES **Vital Signs** NO

FIRST AID

YES **Vital Signs** NO

FIRST AID

YES or unknown **Airway Patent** NO

≥30°C **Core Temperature at extrication** <30°C or unknown

____ . ____ °C

Follow standard ALS guidelines
STOP or go to appropriate medical facility

ALS Provider Name:

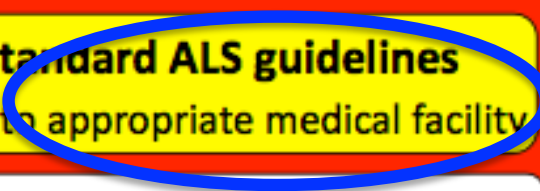

Contents

1. Introduction
2. Concept
3. Definitions
4. BLS Provider Phase
5. ALS Provider Phase
6. Examples
7. Conclusions

6. Conclusions: take home message

- **Every avalanche victim is assigned a checklist**
(complete or partial burial)
- Mark all available information on the checklist step-by-step and parallel to the management/treatment of the patient.
- Give the checklist to the hospital staff. It should be included as part of the patient's medical records.
- Make a copy of both sides of the checklist and include it with a copy of the mission protocol.

6. Conclusions

- The ***Avalanche Victim Resuscitation Checklist*** is the product of experience and research and has been validated internationally.
- The aim of the checklist is to optimize the process of treating avalanche victims, from the first responder to the hospital:
 - increase in adherence to the avalanche algorithm
 - more comprehensive data collection and guaranteed information transfer between prehospital and in-hospital teams.
- The checklist can increase resuscitation and survival rates of those patients with the best survival chances: **hunt for hypothermia**.

6. Conclusions

- The checklist is a pre-hospital tool that can help rescuers follow a standardized procedure. This permits them to continue management without hesitating and can be referred to at any stage of the rescue mission and by a rescuer with any level of training.
- The checklist should save time and not delay rescue activities.
- In 2014 for the first time, the ***Avalanche Victim Resuscitation Checklist*** was introduced into practice in many countries worldwide.

We are always looking to improve the checklist. Any comments are greatly appreciated: avalanche.checklist@gmail.com



Hunt for hypothermia!

ECG monitoring and core temperature measurement are mandatory before an avalanche victim is declared dead.